

Rohinson[®]

Manual Instructions
Portable Air conditioner R-8916



Please read this manual thoroughly before using it and save it for future reference.

SAFETY INSTRUCTIONS

Important

- Carefully read the instructions before operating the unit.
- This appliance is for indoor use only.
- Rating: This unit must be only connected to a 220-240V / 50 Hz earthed outlet. The fuse rating can be found on the plug itself.
- Installation must be in accordance with the applicable regulations of the country where the unit is used.
- If you have any doubt about the suitability of your electrical supply, have it checked and, if necessary, modified by a qualified electrician.
- This appliance is not intended for use by people (including children) with reduced physical, sensory or mental capabilities. It is also not intended for use by those with a lack of experience and knowledge unless they have been given supervision or instruction concerning the use of the appliance by a person responsible for their safety.
- Do not leave children unsupervised with this appliance.
- You must follow the venting and set-up instructions; Incorrect operation can result in damage to the unit, which is not covered under your warranty.
- This air conditioner has been tested and is safe to use. However, as with any electrical appliance-use it with care.
- Do not obstruct any of the ventilation openings.
- The airflow should never be restricted, for example, by venting the unit into a condenser box or reducing the hose diameter, as this can damage the unit.
- Disconnect the power from the appliance before dismantling, assembling or cleaning.

- An authorized service representative should perform any service other than regular cleaning or filter replacement. Failure to comply could result in a voided warranty.
- Avoid touching any moving parts of the appliance.
- Never insert fingers, pencils or any other objects through the guard.
- **WARNING:** Do not pierce or burn any part of the unit.
- Do not clean the unit by spraying it or immersing it in water.
- Never connect the unit to an electrical outlet using an extension cord. If an outlet is not available, one should be installed by a qualified electrician.
- Never operate this appliance if the cord or plug is damaged. Ensure the power cord is not stretched or exposed to sharp objects/edges.
- A damaged supply cord should be replaced by the manufacturer or a qualified electrician to avoid a hazard.
- Do not use the appliance for any purpose other than its intended use.
- The air conditioner unit must always be stored and transported upright; otherwise, irreparable damage may be caused to the compressor. If there is doubt, we suggest waiting at least 24 hours before starting the unit.
- Avoid restarting the air conditioning unit unless 3 minutes have passed since being turned off. This prevents damage to the compressor.
- Never use the mains plug as a switch to start and turn off the air conditioning unit. Use the provided POWER button located on the control panel.
- Always place the unit on a dry, stable, flat surface.
- The appliance should not be installed in the laundry or wet rooms.
- The appliance must be placed in a room without sources of ignition (for example, open flames, an operating gas appliance or an operating electric heater.)
- R290 refrigerant gas complies with European environmental directives.
- R290 has a low GWP (Global Warming Potential) of 3.

- The air conditioners contain the following quantity of refrigerant gas:





R-8916	230g
--------	------

- Do not install or store in an unventilated space with an area smaller than shown in the table below per system. Smaller room sizes may be suitable if other safety measures are implemented, and a risk assessment conducted

R-8916	11.0 m ²
--------	---------------------

- WARNING:** The appliance must be stored in a room without continuously operating ignition sources, for example, open flames, an operating gas appliance or electric heaters.
- The room must be such as to prevent stagnation of possible leaks of refrigerant gas as there could be a danger of fire or explosion should the refrigerant come into contact with electric heaters, stoves or other ignition sources.
- Only store and use the unit whilst upright; do not lay it down or tip it.
- Do not place the unit near any ovens or other heat sources. This may be dangerous but will lead to the unit working harder and using more energy.
- Do not place the unit in direct sunlight; this can affect its appearance and cause it to work hard and be less energy efficient.
- Refrigerant gas may be odorless.
- Do not use the product and contact the retailer for advice if damage has occurred to the unit, which may have compromised the refrigerant system.
- Any repairs or maintenance must only be conducted by a suitably qualified engineer. Before opening and servicing the unit, the authorized engineer must possess a copy of the manufacturer's service manual and follow the safety information contained within it to ensure all hazards are minimized.

- The refrigerant system should not be perforated or punctured.
- At the end of the unit's lifetime, always dispose in line with local regulations.
- Ensure all storage conditions in the manual are followed.
- WARNING:** Do not use means to accelerate the defrosting process or to clean the unit.

	<p>WARNING: This appliance contains flammable refrigerant. If this leaks and comes into contact with an external ignition source, there is a fire risk.</p>
	<p>CAUTION: The operation manual should be read thoroughly.</p>
	<p>CAUTION: Any service personnel working on the unit should read the service manual prior.</p>
	<p>CAUTION: Information on operation and servicing is in the manual.</p>

ENERGY SAVING AND UNIT SAFETY PROTECTION TIPS

- Do not cover or restrict the airflow from the outlet or inlet grills.
- For maximum performance, the minimum distance from a wall or object be 50cm.
- Keep the filters clean. Under normal conditions, filters should only need cleaning once every three weeks(approximately). Since the filters remove airborne particles, more frequent cleaning may be necessary, depending on the air quality.

-
- For the initial start-up, set the fan speed to maximum and the thermostat to 5 degrees lower than the current temperature. Afterwards, set the fan switch low and set the thermostat to your desired setting.
 - To protect the unit, we recommend not using the cooling function when the ambient temperature exceeds 35°C. The unit's performance may be affected at lower temperatures than this. If a scorching day is predicted, running the unit overnight in the desired room is recommended.

FEATURES

- 3 in 1 cooling, fan and dehumidifier.
- 3-speed fan: Balancing quiet operation with performance.
- 24 Hours Start/ Stop Timer.
- Digital Thermostat: Set the temperature between 16°C and 32°C.
- Remote Control.
- Castors and Handle for Enhanced Portability.
- Auto-Restart to retain the settings in the event of power failure.

PART LIST

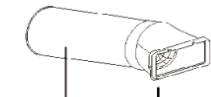
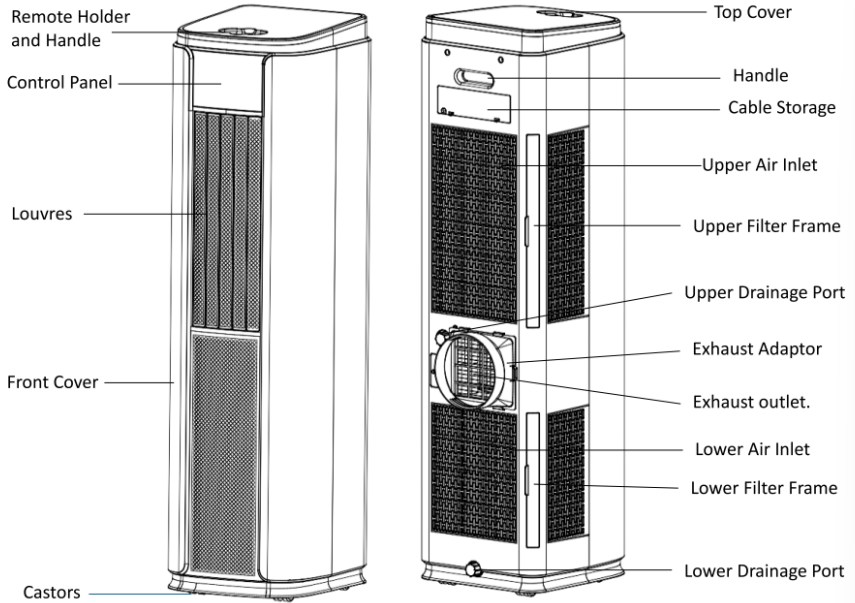

Exhaust Hose

Fishtail Adaptor



Window Slide Bar

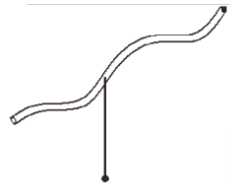

Drainage Pipe

INSTALLATION

WARNING: Before using this unit, please keep it upright for at least 3-4 hours.

This unit can easily be moved from one room to another. While moving the unit, please note that it must always be kept upright and placed on an even surface.

- 1) Attach the fishtail connector to the end of the hose by extending the end and twisting until firmly attached to the connector (At least 3 full rotations).
- 2) Attach the Hose to the Exhaust adaptor in the same way by extending the end of the hose and twisting until firmly attached (At least 3 full rotations).

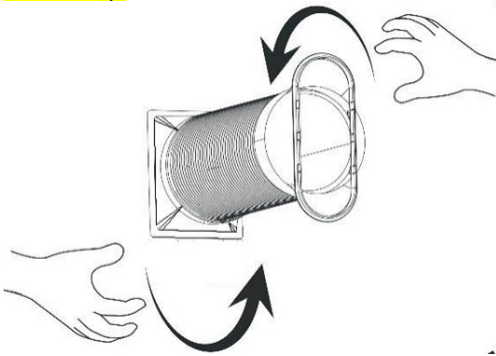

- 3) Clip the Exhaust adaptor into position on the rear of the unit (To remove the adaptor, press the clips down to release it from the unit).

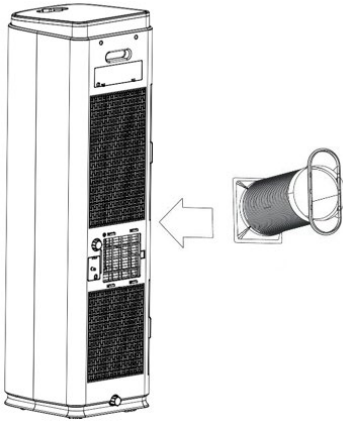

- 4) Make sure the unit is upright, and there are no obstructions to the air inlets and outlet grills, with at least 50cm of space to the side and rear of the unit.

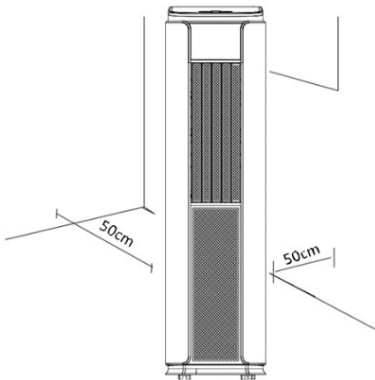

INSTALLATION OF THE WINDOW KIT

The window kit (slide bar and fishtail adapter) can be used with sliding windows and doors. For other types of windows, the fishtail adaptor should be used on its own.

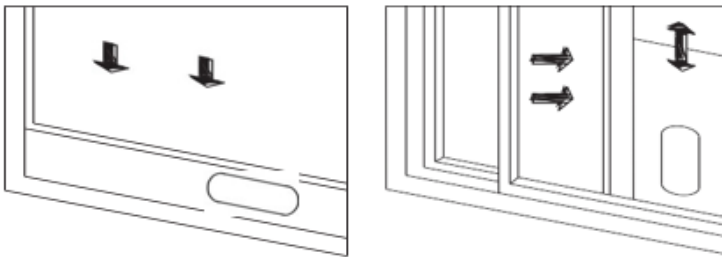

1. Slide the rear section of the slide bar onto the front section, lining up the plate so it runs within the groove. Extend the bar to the required length and use the supplied wing nut to secure it.



2. Push the screw thread of the plate through the hole in the rear of the front slide bar section.

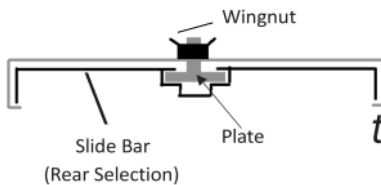

3. Partially open the window and place the extended slide bar in position before closing the window onto it.
4. Fix the fishtail adaptor into the opening on the slide bar.

NOTES:

- The window kit is only designed to be installed with sliding or sash windows or doors. The window kit is not designed to be used with any other style of windows.
- The fishtail adaptor can be used without the slide bar with most windows/doors.
- When using the air conditioner, ensure that the opening around the fishtail adaptor is as small as possible to ensure the unit's efficiency is not reduced.
- The best form of installation is through a wall duct. By adequately venting, you expel hot air from your room while efficiently cooling it.
- Your air conditioner should be used without the vent pipe in dry mode. When using dry mode, ensure that an external water tank is used, monitored and regularly emptied before overflowing. Permanent plumbing can also be installed, or an external uplift water pump can be set up to allow uninterrupted use.

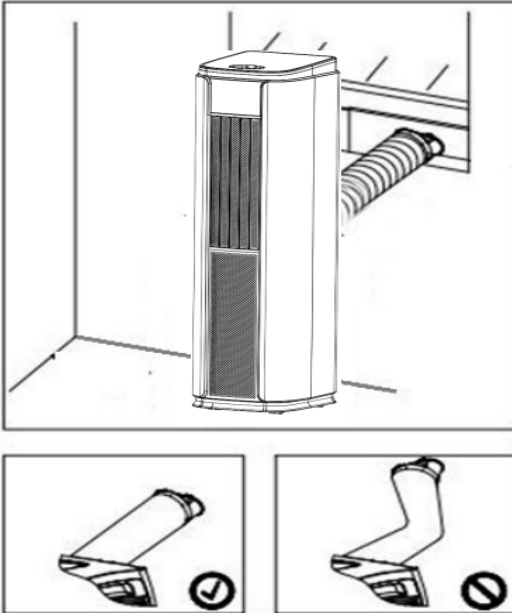

IMPOTANT SAFEGUARDS









The length of the soft hose extends from approximately 30cm to 180cm. If the hose is extended above this length, the unit may malfunction, which can invalidate the warranty. The outlet vent must be well-ventilated and not obstructed, as this will cause the unit to overheat. Keep the hose as straight and short as possible and avoid bending the air hose by more than 30 degrees to maintain the unit's performance. Excessive bends in the hose may prevent the unit from expelling hot air, leading to internal damage, and invalidating the warranty.

OPERATION











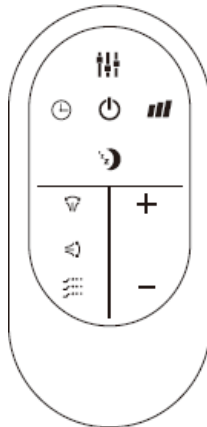

	<p>Press the POWER button to turn the unit ON or OFF.</p>
	<p>Press the MODE button to cycle between the 4 modes, and the indicator for the selected mode will be illuminated.</p> <p>COOL: The room is cooled with the cold air expelled through the front air outlet while hot air is expelled through the vent pipe. The desired room temperature can be set between 16 and 32 degrees using the + and – buttons, and the fan speed can be changed using the SPEED button.</p> <p>FAN: The fan speed can be changed by pressing the SPEED button.</p> <p>DRY: It should be operated without the vent hose but with continuous drainage to remove moisture from the air. The unit will run at low fan speed, with Dh shown in the display. Do not use it when the room temperature is below 15 degrees.</p> <p>SMART COOL: An intelligent cooling mode where the fan</p>

	<p>speed is automatically adjusted based on the amount of cooling required. Attempts to change the fan speed will move the unit into COOL mode.</p>
	<p>Press the SPEED button to change between the 3 fan speeds. The display and LEDs will indicate the currently selected fan speed. The fan speed cannot be altered in AUTO and DRY modes.</p>
	<p>Press to enter sleep mode. The sleep indicator will be illuminated, and all other indicators will be turned off. In sleep mode, the appliance works at low fan speed. Press SLEEP again to exit sleep mode.</p>
	<p>The timer functions cannot be combined or repeated.</p> <p>POWER IN TIMER</p> <p>With the appliance on standby, press the TIMER button to set the power-on timer. Use the + and – buttons to adjust the timer’s duration (1 to 24 hours). The Timer indicator will turn on, and the unit will start after the selected number of hours.</p> <p>POWER OFF TIMER</p> <p>Press the TIMER button to set the power-off timer so the appliance runs with the desired settings. Use the + and _ buttons to adjust the timer’s duration (1 to 24 hours). The timer indicator will illuminate, and the unit will stop after a selected number of hours.</p>
	<p>Used the + and – buttons to adjust the temperature in COOL and AUTO mode. They are also used to set the duration of the TIMER. The buttons are not used in Fan or Dry modes. Press</p>

	both buttons together to change between displaying the temperature in Celsius and Fahrenheit.
	<p>Use to enable the swing function.</p> <p>Press SWING to activate and deactivate the up-down swing.</p> <p>Press and hold SWING for 3 seconds to activate and deactivate the left-right swing.</p>
	<p>The SMOOTH AIR function is designed to provide smooth, soft airflow while ensuring quiet operation with the low fan speed. It provides a gentle refreshing breeze by utilizing the small holes within the louvre to distribute the air.</p> <p>Press the SMOOTH AIR button to activate and deactivate the function.</p> <p>When it is activated, both the up-down& left-right louvre will be fully open. The position of the left-right louvre can be adjusted using the SWING button.</p>

REMOTE CONTROL



	Press to turn the unit on or off.
	Press to change between Cooling, Fan, Dry and AUTO Modes.
	Press to turn the timer on or off.
	Press to adjust the fan speed.
	Press the sleep button to enter sleep mode.
	Press to turn on the left-right swing function.
	Press to turn on the up-down swing function.
	Press to turn on the smooth air function.
	Press to increase the desired temperature.
	Press to decrease the desired temperature.

REPLACING THE BATTERIES

The remote control takes a CR2025 battery. If the remote becomes unresponsive, please change the battery with a new battery, as shown in the image.

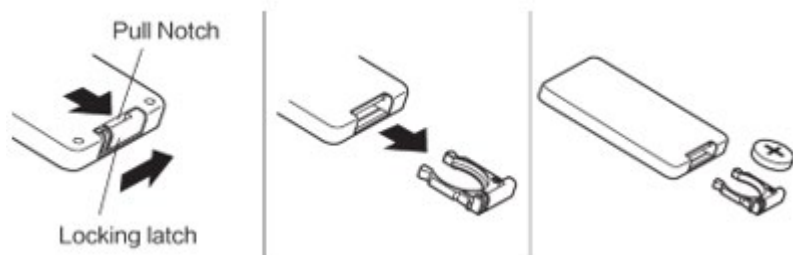

MULTI PROTECTIVE FUNCTIONS

FROST PROTECTION

In COOL, DRY or AUTO modes, if the temperature of the exhaust is too low, the machine will automatically stop operating until the temperature has risen.

OVERFLOW PROTECTION

When the water in the internal water tank exceeds the warning level, the machine will stop operating and sound an alarm with the LCD showing "E4". To resume operation, empty the internal water tank. After emptying the water, the machine will automatically return to its original state.

AUTO-DEFROST

The machine has an automatic defrosting function. If the temperature drops too low during operation, the unit will enter auto defrost, and the heating symbol will flash on the control panel.

AUTOMATIC THERMAL PROTECTION

To protect the service life of the machine, the machine has automatic thermal protection. If the temperature within the unit is outside of the specified range, the compressor and the lower motor will stop operation. After the machine's temperature recovers, the appliance will automatically return to regular operation.

COMPRESSOR PROTECTION

There is a 3-minute delay in starting the function to prevent damage to the compressor.

POWER DOWN MEMORY

If power is cut from the unit, when it is restored, the air conditioner will resume working with the same settings as before the power interruption (After the compressor protection period). Note: any timer that was set prior to the power interruption will not be saved.

CLEANING AND MAINTENANCE

PLEASE SHUT OFF THE UNIT AND UNPLUG FROM THE MAINS BEFORE CLEANING OR PERFORMING ANY MAINTENANCE.

CLEAN THE SURFACE

Clean the machine's surface with a wet, soft cloth. Do not use chemicals such as benzene, alcohol or gasoline as acidic, corrosive, and alkaline

substances may cause damage to the surface and or the internal workings of the machine.

AIR FILTER CLEANING

If the filter screen is clogged with dust, the air conditioner's effectiveness is reduced. The filter screen should be cleaned once every two weeks or as often as necessary in your environment.

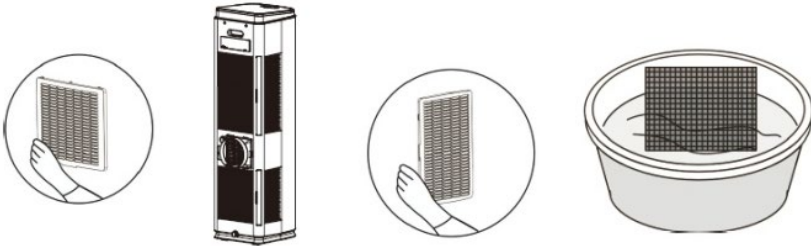

CLEAN THE TWO FILTER SCREEN FRAMES

Remove the filter screens by pulling the base of it gently outwards to unclip it from the appliance. Once removed, put the evaporator filter screen into warm water with neutral detergent (about 40°C) and dry it in the shade after rinsing it clean.

EMPTYING THE INTERNAL WATER TANK

When the internal water tank is full, the unit will stop working and display E4. There are 3 options of how to drain the internal water tank:

1) PUMP ASSISTED DRAINAGE

Remove the rubber stopper from the upper drain port. Connect a drainage pipe (12mm internal diameter) to the drain port, and route it to a suitable drain. Press and hold the SMOOTH AIR button to start the pump and drain the water tank.

2) MANUAL DRAINAGE:

The unit should be manually drained following END-OF-SEASON maintenance before any prolonged period of storage. Turn off the unit and unplug. Avoid moving the model abruptly, as this may cause the water in the internal tank to spill out. Place a tray in a drainage area under the lower drain port. Remove the rubber stopper from the drain port- water will drain from the internal tank. Once the is empty, place the rubber stopper back in position.

3) CONTINUOUS DRAINAGE:

Remove the rubber stopper from the lower drain port. Connect a drainage pipe (12mm internal diameter) to the drain port. You can plumb this pipe into your current plumbing system, lead it outside, use gravity fall, or use an external water pump.

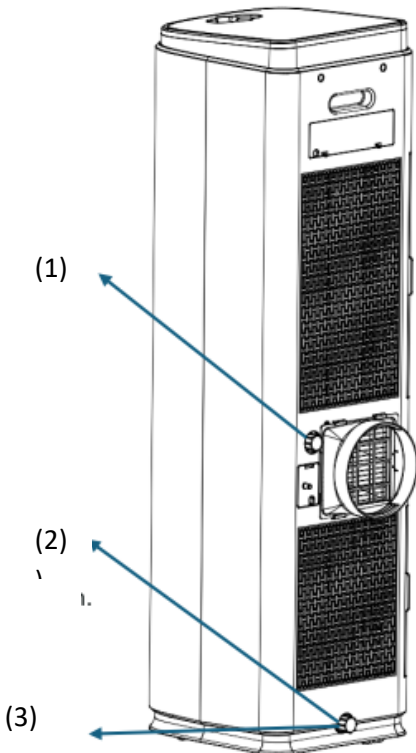

NOTE: This models has a self-evaporative function, which reduces the need to empty the water tank in cooling mode. If the unit is vented correctly, most of the water is reused to cool the condenser coils, and any excess is evaporated. Please do not use continuous drainage if you intend to use the self-evaporating facility.

END-OF-SEASON MAINTENANCE

1. Remove the rubber stoppers from the drainage holes and empty the internal tank. You can also drain the water by leaning the unit backwards.
2. Run the unit in fan mode, with a low fan speed, with the rubber stopper still removed and a container under the lower drain port.
3. Keep the unit in this mode for half a day- until the conduit is dried. Doing this helps to keep the inside of the unit dry and prevents mould from developing.
4. Turn off the unit and disconnect the plug.
5. Replace the rubber stopper.
6. Coil the cable, bind it together, and put it into the cable storage compartment.
7. Separate the vent pipe and store it safely.
8. Cover the unit and keep it in a dry place.
9. Take the batteries out of the remote control and store or dispose of them safely.
10. Keep all accessories with the unit ready for next season.

TROUBLESHOOTING

Do not repair or disassemble the air conditioning. Unqualified repair will invalidate the warranty may lead to failure, causing injuries and property damage. Only use it as directed in this user manual and only perform operations advised here.

Problems	Reasons	Solutions
The air conditioner does not work.	There is no electricity.	Please turn it on after connecting it to a socket with electricity.
	The display shows	Discharge the water

	“E4”	inside.
	The ambient temperature is too low or too high.	Only use the machine within a temperature range of 7-35°C
	In cooling mode, the room temperature is lower than the desired temperature.	Change the desired temperature.
	In dry mode, the ambient temperature is low.	The ambient temperature must be above 17°C.
The cooling effect is not good.	There is direct sunlight.	Use curtains to reduce the direct sun heat.
	Doors or windows are open; there are a lot of people; or in cooling mode, there are other sources of heat (e.g. fridges)	Close doors and windows; increase air conditioning power.
	The filter screen is dirty.	Clean or replace the filter screen.
	The air inlet or outlet is blocked.	Clear obstructions: make sure venting is correct as described in this user manual and the hose is not bent.
Loud Noise	The air conditioning is not placed on a flat surface.	Put the air conditioning in a flat, hard place(to reduce noise).

The compressor does not work.	Overheat protection starts.	Wait 3 minutes until the temperature is lowered, then restart the machine.
The remote control does not work.	The distance between the machine and the remote control is too far.	Let the remote control get close to the air conditioner and ensure that the remote control directly faces the receiver.
	The remote control is not aligned with the receiver.	
	Batteries are dead.	Replace batteries.
Others	No refrigerant or there is minimal refrigerant.	Refer to Service Center(check leakage, welding, vacuum pump, charge refrigerant according to nameplate).
	Anti-freezing protection.	Waiting for defrosting. The function will recover automatically. No user input is needed.
	High-pressure protection.	After the inside gas pressure comes down, it will function normally. No user input is needed.

If problems not listed in the table occur or recommended solutions do not

work, please get in touch with the Service Centre.

1. Has the unit been standing upright for at least 2 hours?
2. Is the unit plugged into the mains?
3. Is the fuse, OK?
4. Switch the unit off and wait three minutes to see if the issue is resolved. Restart the unit.
5. Check if the water tank is full.

ERROR CODES

CODE	CAUSE	SOLUTION
E2	Room temperature sensor error	Check to ensure filters are clean, vent pipe is not re
E3	Air temperature sensor Error	
E4	Water tank full	Empty the water tank.
ES	Coil temperature sensor error	Check to ensure filters are clean, vent pipe is not restricted, and room temperature is within operational range.
COOL/ DRY/ AUTO LIGHT FLASHING	This in normal- shows which mode is operating, but that the compressor is not running.	The unit will start operation when the protection period has finished (approx. 3 minutes).



IMPORTANT INFORMATION FOR CORRECT DISPOSAL OF THE PRODUCT IN ACCORDANCE WITH EC DIRECTIVE 2012/19/EU.

At the end of its working life, the product must not be disposed of as urban waste. It must be taken to a special local authority differentiated waste collection center or to a dealer providing this service. Disposing of a household appliance separately avoids possible negative consequences for the environment and health, deriving from inappropriate disposal and enables the constituent materials to be recovered to obtain significant savings in energy and resources. As a reminder of the need to dispose of household appliances separately, the product is marked with a crossed-out wheeled dustbin.