

Rohnson®

VACUUM CLEANER

MODEL: R-1224

INSTRUCTION MANUAL



**Please read this instruction manual carefully before use
Please retain this manual for future reference'.**

Safety instructions



Attention: it may have risk for product or other object when using it.



Dangerous: Please take it far from object or liquid which easy to fire or exposed in order to prevent the fire or explosion when operating.



Warning:

1. this machine use washable filter system with convenient operation and effective cleaning.
2. this machine use cyclone filter system with bagless design
3. this machine is suitable for cleaning home, hotel, building with low noise and long life, which make life better
4. with dust cup design which is easy to detach and wash

IMPORTANT SAFETY INSTRUCTIONS

WARNINGS & CAUTIONS

To avoid electric shocks

- Do not use the appliance outdoors.
- Never use the vacuum cleaner if the cable, plug or casing are damaged.
- To avoid risks, arrange for damaged power cables and/or plugs to be replaced as soon as possible by a qualified specialist.
- Arrange for repairs to be carried out only by specialist workshops. Under no circumstances should you open the appliance yourself. Repairs that is not carried out by a specialist workshop could lead to physical injuries and void your warranty.
- Before switching the hand vacuum cleaner on, ensure that the mains voltage corresponds to the voltage indicated in the technical data label for the appliance.
- Never touch the power supply or the appliance with wet or damp hands
- Always unplug the appliance when not in use!!
- Do not use extension cables or leads with this appliance!

To avoid the risk of injury!

- Do not change any accessories while the appliance is switched on.
- Do not use the vacuum cleaner for vacuuming up sharp objects or glass shards
- Do not insert foreign objects into the air flow vents
- Never vacuum up burning matches, glowing ashes or cigarette butts.
- Do not use the vacuum cleaner for vacuuming up chemical products, stone dust,

gypsum, cement or similar particles.

- Do not use the vacuum cleaner for vacuuming up liquid, water or similar particles.
- This appliance is not suitable for use with inflammable and explosive substances or chemical and aggressive liquids.
- Always store the appliance indoors. To prevent accidents, keep the appliance in a dry location when not in use and out of reach for small children.
- This appliance can be used by children aged from 8 years and above and persons with reduced physical, sensory or mental capabilities or lack of experience and knowledge if they have been given supervision or instruction concerning use of the appliance in a safe way and understand the hazards involved.
- Children shall not play with the appliance. This appliance is NOT a toy.
- Cleaning and user maintenance shall not be made by children without supervision.
- This appliance is not for commercial use! It is for household use only
- The plug must be removed from the socket-outlet before cleaning or maintaining the appliance.
- If the supply cord is damaged, it must be replaced by the manufacturer, its service agent or similarly qualified persons in order to avoid a hazard.

Tips for safety:

- Use only accessory parts recommended by the manufacturer.
- Always grip the power plug to disconnect the appliance from the power supply.
- Always be sure to keep the vacuum away from heating elements, ovens or other heated appliances and surfaces.
- Always make certain that the ventilation slits are open. A blocked ventilation circuit can result in overheating and damage to the appliance.
- Take special care when using the vacuum on stairs.
- Do not use the vacuum without the dust filter inserted.
- Take extra care not to trip over the power cord and beware of your surroundings to ensure others do not trip over the power cord.

Product accessories

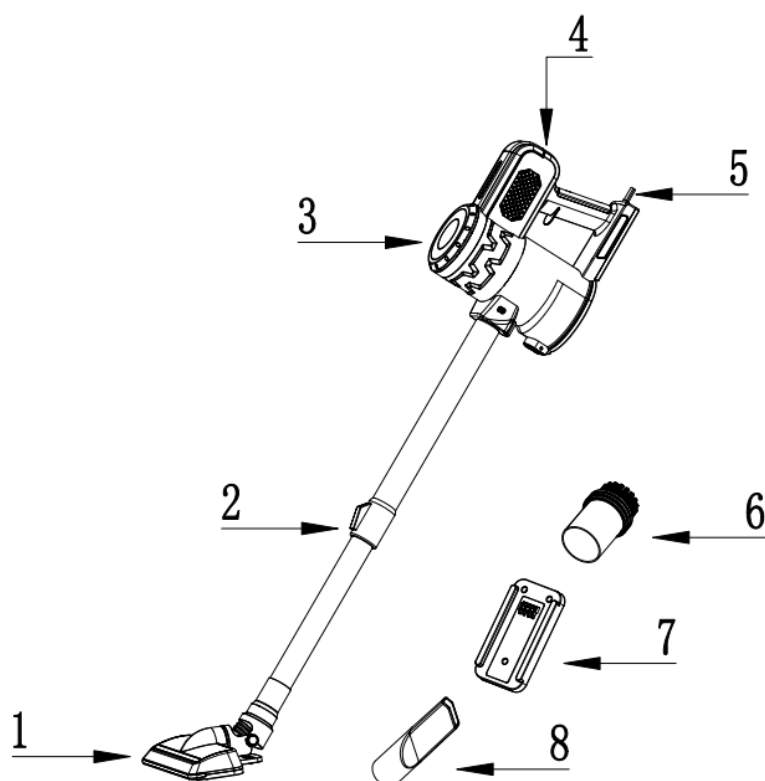

01. Floor brush	05. Cable
02. Telescopic tube	06. Round brush
03. Main body	07. Wall-mount base
04. Switch	08. Crevice nozzle

Installation guide

- Important: When installing or removing the vacuum cleaner, ensure that the vacuum cleaner is not connected to the main power outlet.

CLEANING FILTERS

To ensure the best performance of your appliance, it is important to regularly clean the filters, the bin and check for blockages.

We recommend washing the filters at least once a month and replacing them once a year (You can get them at our authorized services). Filters may need more frequent cleaning and replacement, depending on how often the device is used.

To clean the filters, follow the steps below:

- Shake the filters to remove dust.
- Wash the filters with cold water only.
- Repeat washing the filters until clean water runs.
- Allow the filters to dry completely in a dry area with good air circulation for at least 24 hours.
- Install the filter assembly to the dust cup assembly as shown in the following figure

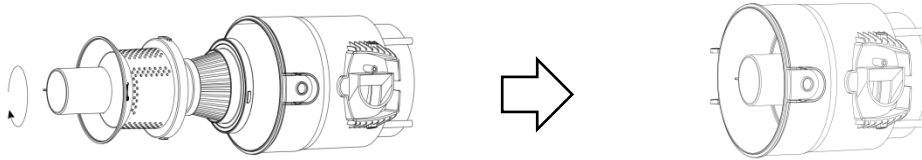

- Simply remove the filter cone from the main body, then remove the filter attachment inside the dust container and dispose of the dust into the dustbin. Then follow the instructions above to reassemble the vacuum.

CAUTION: Do not clean the filters in a washing machine. Do not use a hair dryer to dry them.

- Important: Make sure the dust filter assembly is fully air dried before you put the vacuum back in place.

Install the connecting pipe, main engine and main brush head as shown below

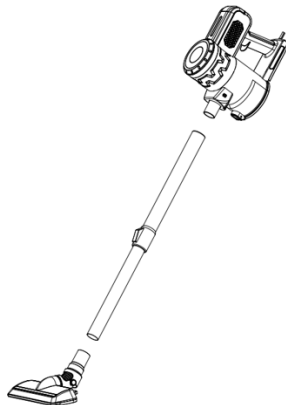

Care and cleaning

Switch off the appliance and pull out the plug from the power supply.

Clean the outside of the appliance with a soft cloth with mild detergent. Harsh or abrasive detergent will damage the outside surface. Never immerse the appliance or cord into water and other liquids.



CAUTION:

When the dust bin is full and reaches the MAX indication, you should empty the dust bin.

Never use the appliance without filters. Do not use a washing machine to rinse filters. Do not use a hair drier to dry them matters need attention.

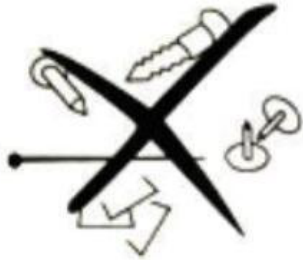

Attention

 <p>pls do not push the power or machine</p>	 <p>forbidden to use machine to suck the lighted cigarette or hot ash</p>
 <p>forbidden to use machine to suck the object with liquid</p>	 <p>pls do not use machine to suck sharp object</p>

Simple trouble shooting

·When using this product such as abnormal, Please review the following table to resolve itself.

Troubleshooting Guide		
The problem	Problems that may occur	Possible solutions
When a hand-held vacuum cleaner doesn't work	Power supply is disconnected.	Checking the Power Interface
The hand-held vacuum cleaner cannot pick up dust and its suction becomes weak	1. The dust collector is full 2. Heippa blocked	1. Clean up dust storage containers 2. Remove the dust filter assembly, check the suction inlet for foreign matter and remove. Clean or replace the heippa
Dust leaks and blocks the wind	1. The dust collector is full 2. The dust storage device is not installed correctly 3. Perforation on dust filter	1. Empty the dust container 2. Check the installation instructions of dust storage assembly 3. Replace the dust filter assembly
Heard a strange noise	Check whether the floor brush and dust filter are blocked by large dust; Check that the dust container is full	Stop using the device immediately, clean the dust filter assembly and floor brush, and empty the dust container. If the problem does not go away, contact the service agent.



IMPORTANT INFORMATION FOR CORRECT DISPOSAL OF THE PRODUCT IN ACCORDANCE WITH EC DIRECTIVE 2002/96/EC.

At the end of its working life, the product must not be disposed of as urban waste. It must be taken to a special local authority differentiated waste collection centre or to a dealer providing this service. Disposing of a household appliance separately avoids possible negative consequences for the environment and health, deriving from inappropriate disposal and enables the constituent materials to be recovered to obtain significant savings in energy and resources. As a reminder of the need to dispose of household appliances separately, the product is marked with a crossed-out wheeled dustbin.